

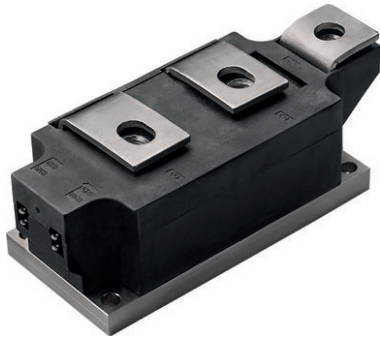



# Standard Diodes, 600 A (SUPER MAGN-A-PAK Power Modules)



SUPER MAGN-A-PAK

### FEATURES

- High current capability
- High surge capability
- High voltage ratings up to 2000 V
- 3000 V<sub>RMS</sub> isolating voltage with non-toxic substrate
- Industrial standard package
- UL approved file E78996 
- Material categorization: for definitions of compliance please see [www.vishay.com/doc?99912](http://www.vishay.com/doc?99912)



RoHS  
COMPLIANT

### TYPICAL APPLICATIONS

- Rectifying bridge for large motor drives
- Rectifying bridge for large UPS

PRODUCT SUMMARY	
I <sub>F(AV)</sub>	600 A
Type	Modules - Diode, High Voltage
Package	SMAP
Circuit	Two SCRs doubler circuit

MAJOR RATINGS AND CHARACTERISTICS			
SYMBOL	CHARACTERISTICS	VALUES	UNITS
I <sub>F(AV)</sub>		600	A
	T <sub>C</sub>	100	°C
I <sub>F(RMS)</sub>		942	A
	T <sub>C</sub>	100	°C
I <sub>FSM</sub>	50 Hz	19 000	A
	60 Hz	20 100	
I <sup>2</sup> t	50 Hz	1805	kA <sup>2</sup> s
	60 Hz	1683	
I <sup>2</sup> √t		18 050	kA <sup>2</sup> √s
V <sub>RRM</sub>	Range	800 to 2000	V
T <sub>Stg</sub> , T <sub>J</sub>	Range	-40 to +150	°C

### ELECTRICAL SPECIFICATIONS

VOLTAGE RATINGS				
TYPE NUMBER	VOLTAGE CODE	V <sub>RRM</sub> , MAXIMUM REPETITIVE PEAK REVERSE VOLTAGE V	V <sub>RSM</sub> , MAXIMUM NON-REPETITIVE PEAK REVERSE VOLTAGE V	I <sub>RRM</sub> MAXIMUM AT T <sub>J</sub> MAXIMUM mA
VS-VSKD600..	08	800	900	50
	12	1200	1300	
	16	1600	1700	
	20	2000	2100	



<b>FORWARD CONDUCTION</b>						
PARAMETER	SYMBOL	TEST CONDITIONS		VALUES	UNITS	
Maximum average forward current at case temperature	$I_{F(AV)}$	180° conduction, half sine wave		600	A	
				100	°C	
Maximum RMS forward current	$I_{F(RMS)}$	180° conduction, half sine wave at $T_C = 100\text{ °C}$		942	A	
Maximum peak, one-cycle forward, non-repetitive surge current	$I_{FSM}$	t = 10 ms	No voltage reappplied	19.0	kA	
		t = 8.3 ms		Sinusoidal half wave, initial $T_J = T_J$ maximum		20.1
		t = 10 ms	100 % $V_{RRM}$ reappplied			16.2
		t = 8.3 ms				17.2
Maximum $I^2t$ for fusing	$I^2t$	t = 10 ms	No voltage reappplied		1805	kA <sup>2</sup> s
		t = 8.3 ms		100 % $V_{RRM}$ reappplied	1683	
		t = 10 ms	1319			
		t = 8.3 ms	1230			
Maximum $I^2\sqrt{t}$ for fusing	$I^2\sqrt{t}$	t = 0.1 ms to 10 ms, no voltage reappplied			18 050	kA <sup>2</sup> √s
Low level value of threshold voltage	$V_{F(TO)1}$	(16.7 % $\times \pi \times I_{F(AV)} < I < \pi \times I_{F(AV)}$ , $T_J = T_J$ maximum)		0.70	V	
High level value of threshold voltage	$V_{F(TO)2}$	(I $> \pi \times I_{F(AV)}$ , $T_J = T_J$ maximum)		0.77		
Low level value of forward slope resistance	$r_{f1}$	(16.7 % $\times \pi \times I_{F(AV)} < I < \pi \times I_{F(AV)}$ , $T_J = T_J$ maximum)		0.28	mΩ	
High level value of forward slope resistance	$r_{f2}$	(I $> \pi \times I_{F(AV)}$ , $T_J = T_J$ maximum)		0.25		
Maximum forward voltage drop	$V_{FM}$	$I_{pk} = 1800\text{ A}$ , $T_J = 25\text{ °C}$ , $t_p = 10\text{ ms}$ sine pulse		1.45	V	

<b>BLOCKING</b>					
PARAMETER	SYMBOL	TEST CONDITIONS		VALUES	UNITS
RMS insulation voltage	$V_{INS}$	t = 1 s		3000	V
Maximum peak reverse and off-state leakage current	$I_{RRM}$	$T_J = T_J$ maximum, rated $V_{RRM}$ applied		50	mA

<b>THERMAL AND MECHANICAL SPECIFICATIONS</b>					
PARAMETER	SYMBOL	TEST CONDITIONS		VALUES	UNITS
Maximum junction operating and storage temperature range	$T_J, T_{Stg}$			-40 to 150	°C
Maximum thermal resistance, junction to case per junction	$R_{thJC}$	DC operation		0.065	K/W
Maximum thermal resistance, case to heatsink per module	$R_{thC-hs}$	Mounting surface smooth, flat and greased		0.02	
Mounting torque ± 10 %	SMAP to heatsink	A mounting compound is recommended and the torque should be rechecked after a period of 3 hours to allow for the spread of the compound.		6 to 8	Nm
	busbar to SMAP			12 to 15	
Approximate weight				1500	g
Case style		See dimensions - link at the end of datasheet		SUPER MAGN-A-PAK	

<b><math>\Delta R_{thJC}</math> CONDUCTION</b>				
CONDUCTION ANGLE	SINUSOIDAL CONDUCTION	RECTANGULAR CONDUCTION	TEST CONDITIONS	UNITS
180°	0.009	0.006	$T_J = T_J$ maximum	K/W
120°	0.011	0.011		
90°	0.014	0.015		
60°	0.021	0.022		
30°	0.037	0.038		

**Note**

- The table above shows the increment of thermal resistance  $R_{thJC}$  when devices operate at different conduction angles than DC

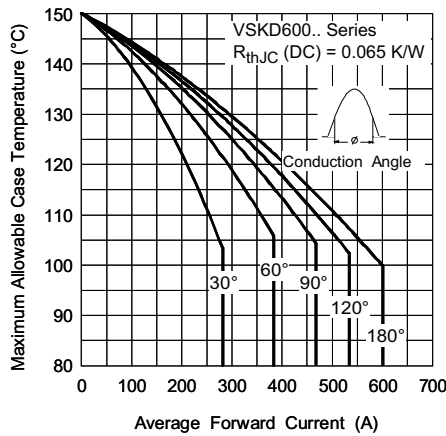

Fig. 1 - Current Ratings Characteristics

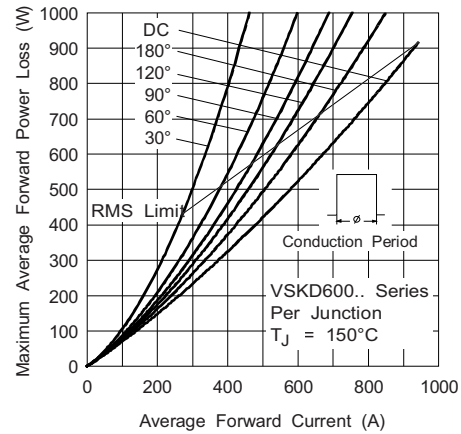

Fig. 4 - Forward Power Loss Characteristics

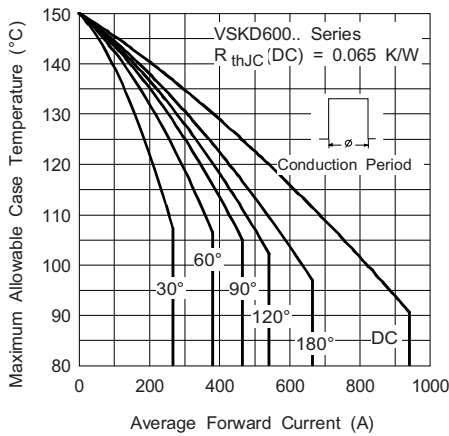

Fig. 2 - Current Ratings Characteristics

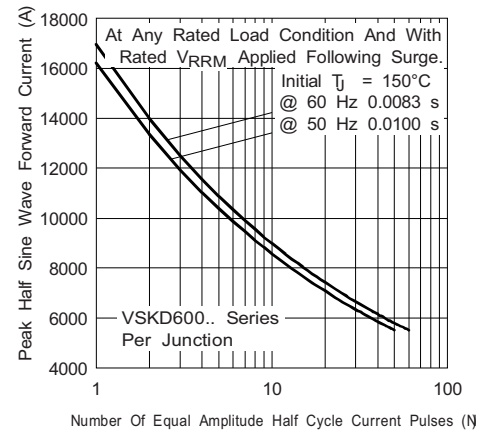

Fig. 5 - Maximum Non-Repetitive Surge Current

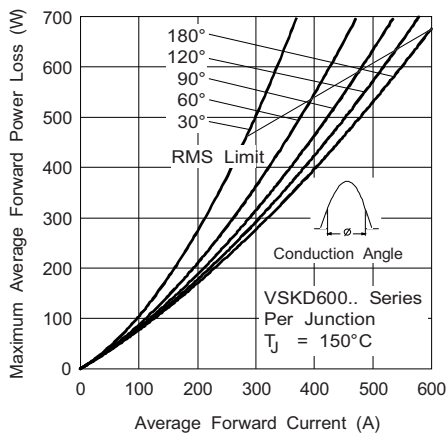

Fig. 3 - Forward Power Loss Characteristics

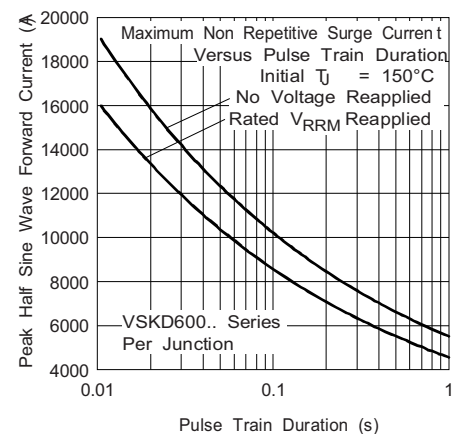

Fig. 6 - Maximum Non-Repetitive Surge Current

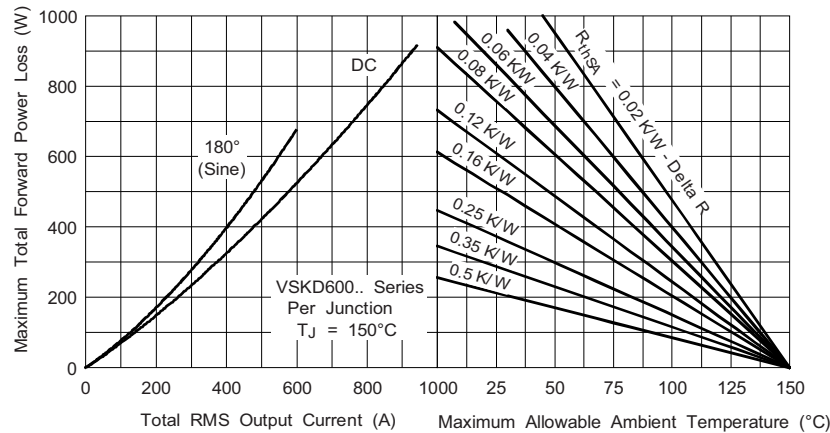

Fig. 7 - Forward Power Loss Characteristics

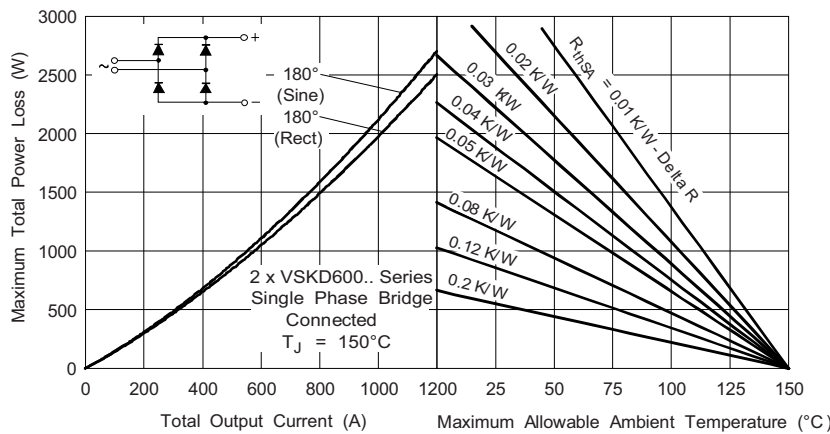

Fig. 8 - Forward Power Loss Characteristics

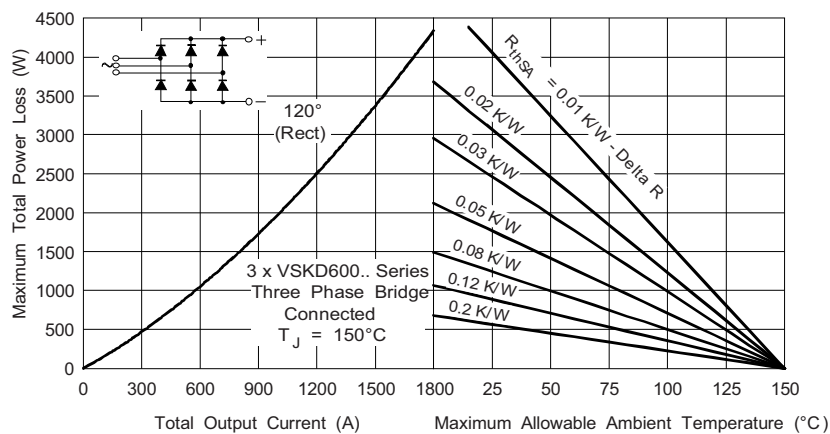

Fig. 9 - Forward Power Loss Characteristics

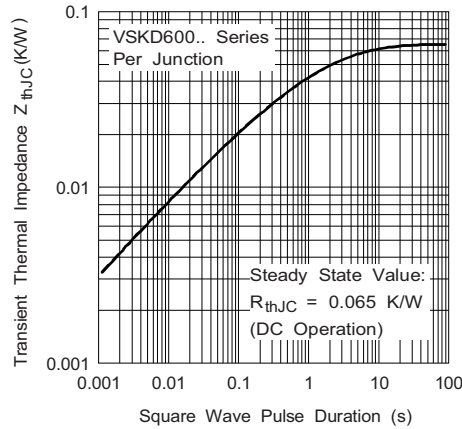

Fig. 10 - Thermal Impedance  $Z_{thJC}$  Characteristic

**ORDERING INFORMATION TABLE**

Device code	<b>VS-</b>	<b>VSK</b>	<b>D</b>	<b>600</b>	<b>-</b>	<b>20</b>
	①	②	③	④		⑤
	<b>1</b>	-	Vishay Semiconductors product			
	<b>2</b>	-	Module type			
	<b>3</b>	-	Circuit configuration D = 2 diodes in series (see Circuit Configuration table)			
	<b>4</b>	-	Current rating			
	<b>5</b>	-	Voltage code x 100 = $V_{RRM}$ (see Voltage Ratings table)			

<b>CIRCUIT CONFIGURATION</b>		
<b>CIRCUIT DESCRIPTION</b>	<b>CIRCUIT CONFIGURATION CODE</b>	<b>CIRCUIT DRAWING</b>
Two diodes doubler circuit	D	

<b>LINKS TO RELATED DOCUMENTS</b>	
Dimensions	<a href="http://www.vishay.com/doc?95088">www.vishay.com/doc?95088</a>



## Super MAGN-A-PAK Diode

**DIMENSIONS** in millimeters (inches)

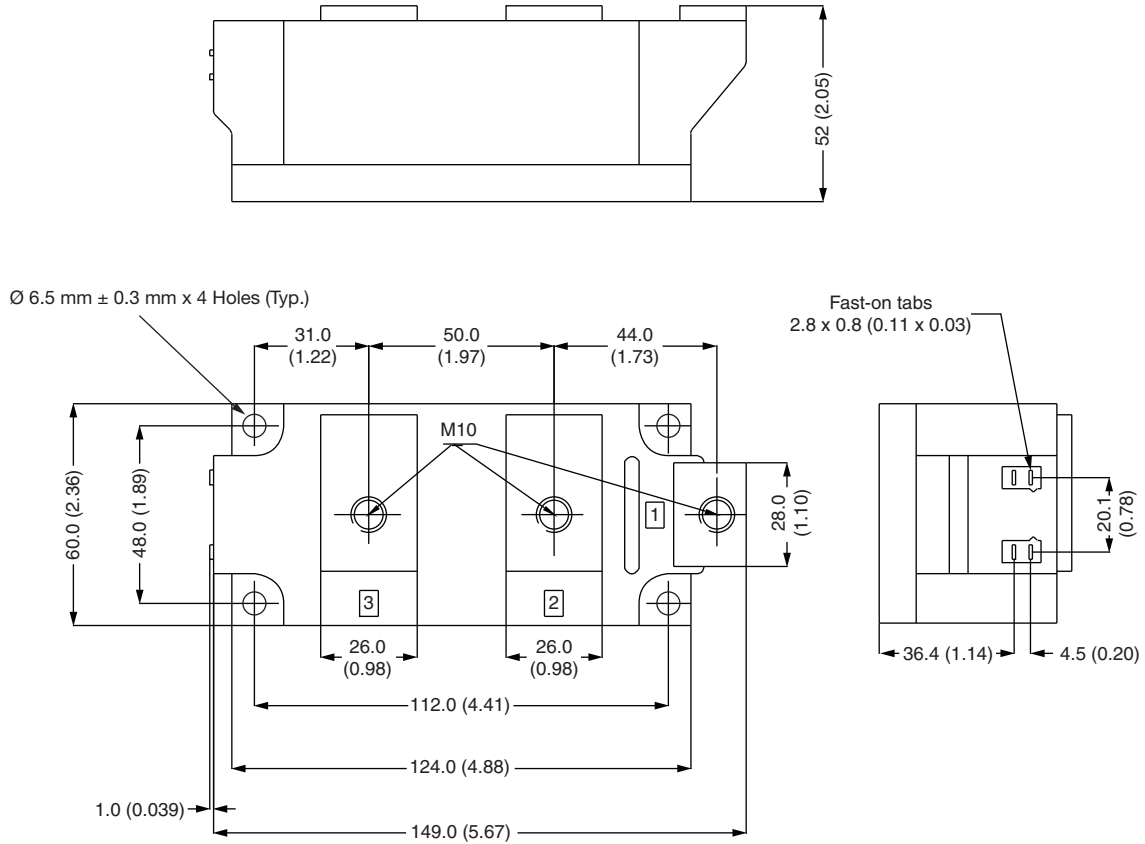



## Super MAGN-A-PAK Thyristor/Diode

**DIMENSIONS** in millimeters (inches)

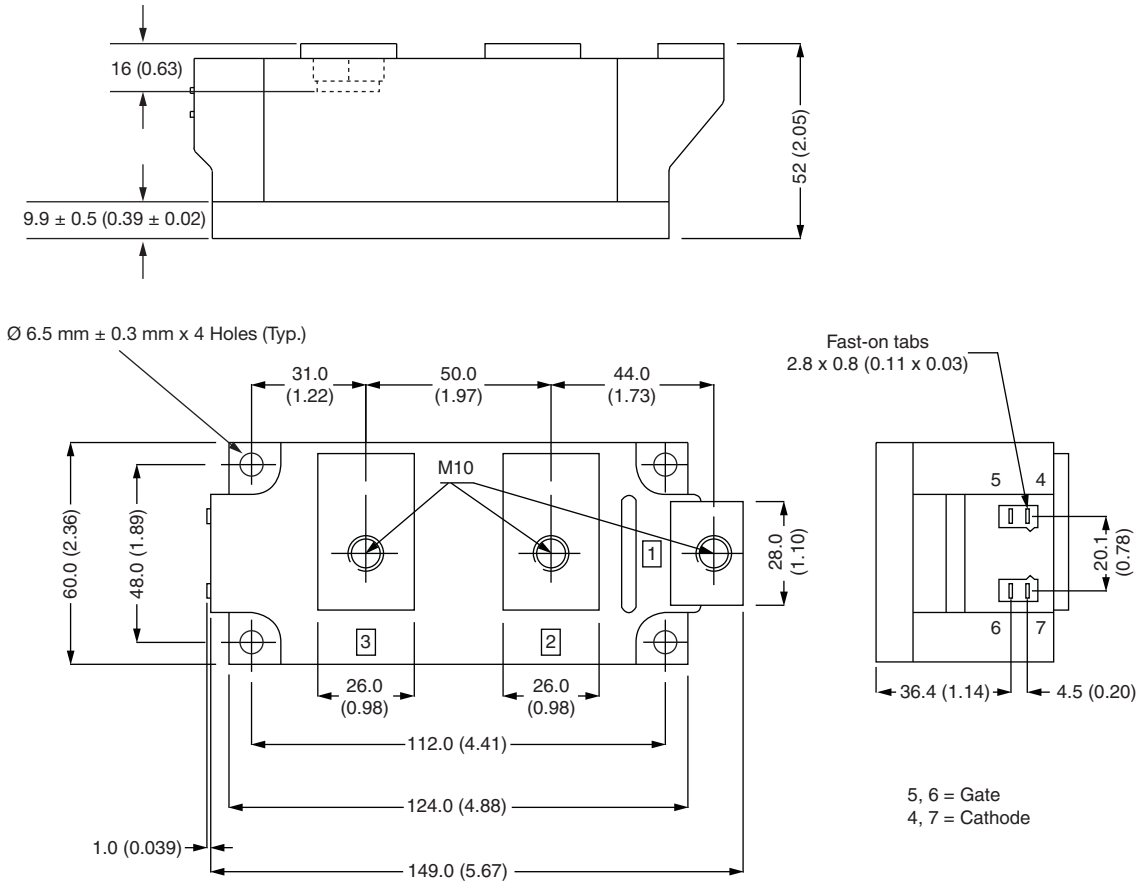



## Disclaimer

ALL PRODUCT, PRODUCT SPECIFICATIONS AND DATA ARE SUBJECT TO CHANGE WITHOUT NOTICE TO IMPROVE RELIABILITY, FUNCTION OR DESIGN OR OTHERWISE.

Vishay Intertechnology, Inc., its affiliates, agents, and employees, and all persons acting on its or their behalf (collectively, "Vishay"), disclaim any and all liability for any errors, inaccuracies or incompleteness contained in any datasheet or in any other disclosure relating to any product.

Vishay makes no warranty, representation or guarantee regarding the suitability of the products for any particular purpose or the continuing production of any product. To the maximum extent permitted by applicable law, Vishay disclaims (i) any and all liability arising out of the application or use of any product, (ii) any and all liability, including without limitation special, consequential or incidental damages, and (iii) any and all implied warranties, including warranties of fitness for particular purpose, non-infringement and merchantability.

Statements regarding the suitability of products for certain types of applications are based on Vishay's knowledge of typical requirements that are often placed on Vishay products in generic applications. Such statements are not binding statements about the suitability of products for a particular application. It is the customer's responsibility to validate that a particular product with the properties described in the product specification is suitable for use in a particular application. Parameters provided in datasheets and/or specifications may vary in different applications and performance may vary over time. All operating parameters, including typical parameters, must be validated for each customer application by the customer's technical experts. Product specifications do not expand or otherwise modify Vishay's terms and conditions of purchase, including but not limited to the warranty expressed therein.

Except as expressly indicated in writing, Vishay products are not designed for use in medical, life-saving, or life-sustaining applications or for any other application in which the failure of the Vishay product could result in personal injury or death. Customers using or selling Vishay products not expressly indicated for use in such applications do so at their own risk. Please contact authorized Vishay personnel to obtain written terms and conditions regarding products designed for such applications.

No license, express or implied, by estoppel or otherwise, to any intellectual property rights is granted by this document or by any conduct of Vishay. Product names and markings noted herein may be trademarks of their respective owners.

## Material Category Policy

**Vishay Intertechnology, Inc. hereby certifies that all its products that are identified as RoHS-Compliant fulfill the definitions and restrictions defined under Directive 2011/65/EU of The European Parliament and of the Council of June 8, 2011 on the restriction of the use of certain hazardous substances in electrical and electronic equipment (EEE) - recast, unless otherwise specified as non-compliant.**

**Please note that some Vishay documentation may still make reference to RoHS Directive 2002/95/EC. We confirm that all the products identified as being compliant to Directive 2002/95/EC conform to Directive 2011/65/EU.**

**Vishay Intertechnology, Inc. hereby certifies that all its products that are identified as Halogen-Free follow Halogen-Free requirements as per JEDEC JS709A standards. Please note that some Vishay documentation may still make reference to the IEC 61249-2-21 definition. We confirm that all the products identified as being compliant to IEC 61249-2-21 conform to JEDEC JS709A standards.**



# Mouser Electronics

Authorized Distributor

Click to View Pricing, Inventory, Delivery & Lifecycle Information:

[Vishay:](#)

[VSKD600-08](#) [VSKD600-12](#) [VS-VSKD600-08PBF](#) [VS-VSKD600-16PBF](#) [VS-VSKD600-12PBF](#) [VS-VSKD600-20PBF](#)

[IRKD600-08](#) [IRKD600-12](#) [VSKD600-16](#) [VSKD600-20](#)